



Thyristor Module

K35TH400P160AAA

特徴

Feature

- RoHS 指令準拠
RoHS Compliant

用途

Application

- 一般整流用
For General Use



外形図

Outline Drawing

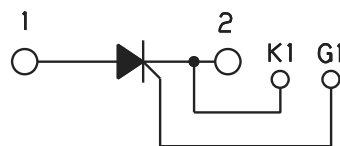
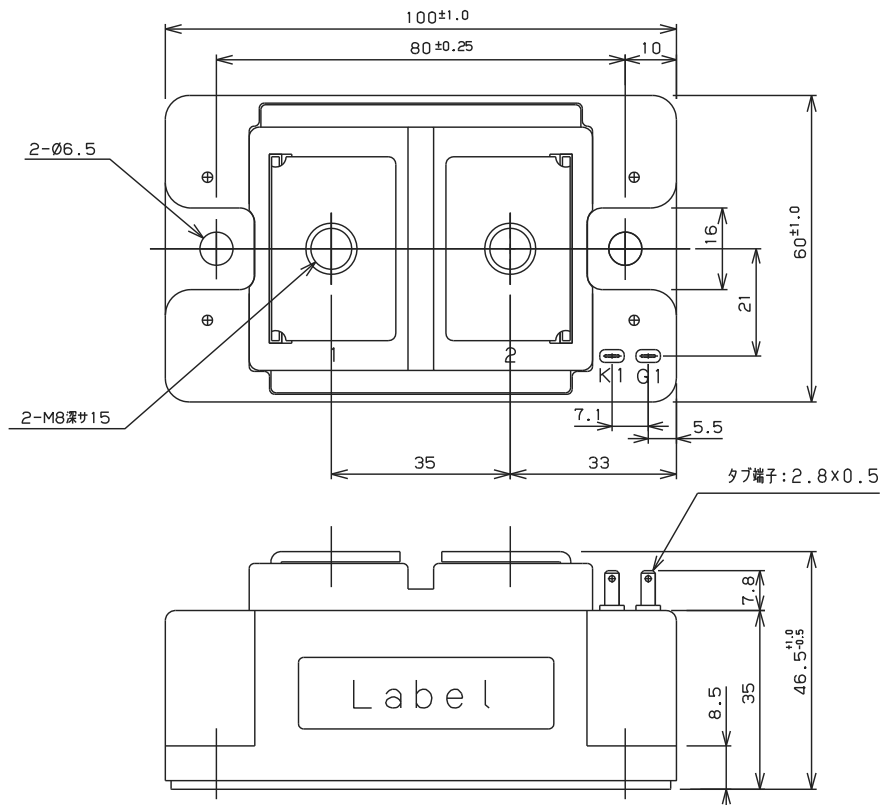

回路構成 Circuit Schema

【単位：mm】

最大定格 Maximum Ratings

| 項目 Parameter | 記号 Symbol | 耐圧クラス Grade | | 単位 Unit |
|---|------------------|-----------------|--|------------|
| | | K35TH400P160AAA | | |
| くり返しピークオフ電圧 Repetitive Peak Off-State Voltage | V _{DRM} | 1600 | | V |
| 非くり返しピークオフ電圧 Non Repetitive Peak Off-State Voltage | V _{DSM} | 1700 | | V |
| くり返しピーク逆電圧 Repetitive Peak Reverse Voltage | V _{RRM} | 1600 | | V |
| 非くり返しピーク逆電圧 Non Repetitive Peak Reverse Voltage | V _{RSM} | 1700 | | V |

| 項目 Parameter | 記号 Symbol | 条件 Conditions | 定格値 Max.Rated Value | 単位 Unit | | |
|---|-------------------------|---|---------------------------------------|------------------|------------|-----|
| 平均整流電流 Average Rectified Output Current | I _{T(AV)} | 商用周波数 180° 通電 T _c = 87°C Half Sine Wave | 400 | A | | |
| 実効オン電流 RMS On-State Current | I _T (RMS) | | 630 | A | | |
| サージオン電流 Surge On-State Current | I _{TSM} | 50Hz 正弦半波, 1 サイクル, 非くり返し Half Sine Wave, 1Pulse, Non-Repetitive | 7200 | A | | |
| 電流二乗時間積 I Squared t | I ² t | 2~10ms | 259000 | A ² s | | |
| 臨界オン電流上昇率 Critical Rate of Rise of Turned-On Current | di/dt | V _D = 2/3V _{DRM} I _{TM} = 2I _T , T _j = 125°C I _G = 300mA, di _G /dt= 0.2A/μs | 100 | A/μs | | |
| ピークゲート電力損失 Peak Gate Power | P _{GM} | | 5 | W | | |
| 平均ゲート電力損失 Average Gate Power | P _{G(AV)} | | 1 | W | | |
| ピークゲート電流 Peak Gate Current | I _{GM} | | 2 | A | | |
| ピークゲート電圧 Peak Gate Voltage | V _{GM} | | 10 | V | | |
| ピークゲート逆電圧 Peak Gate Reverse Voltage | V _{RGM} | | 5 | V | | |
| 動作接合温度範囲 Operating Junction Temperature Range | T _{jw} | | -40 ~ +125 | °C | | |
| 保存温度範囲 Storage Temperature Range | T _{stg} | | -40 ~ +125 | °C | | |
| 絶縁耐圧 Isolation Voltage | V _{iso} | 端子ーベース間, AC 1 分間 Terminal to Base, AC 1min. | 2500 | V | | |
| 締付トルク Mounting Torque | ベース部 Base | F | サーマルコンパウンド [®] 塗布 Greased | M6 | 2.5 ~ 3.5 | N・m |
| | 主端子部 Terminal | | | M8 | 9.0 ~ 10.0 | N・m |

1 アーム当りの値 Value Per 1 Arm.

電気的特性 Electrical Characteristics

| 項目 Parameter | 記号 Symbol | 条件 Conditions | | 特性値 Values | | | 単位 Unit |
|--|-----------------|--|---------------------------|---------------|------------|------------|---------------------------|
| | | | | 最小 Min. | 標準 Typ. | 最大 Max. | |
| ピークオフ電流 Peak Off-State Current | I_{DM} | $T_j = 125^\circ\text{C}$, $V_{DM} = V_{DRM}$ | | | | 100 | mA |
| ピーク逆電流 Peak Reverse Current | I_{RM} | $T_j = 125^\circ\text{C}$, $V_{RM} = V_{RRM}$ | | | | 100 | mA |
| ピークオン電圧 Peak On-State Voltage | V_{TM} | $T_j = 25^\circ\text{C}$, $I_{TM} = 1300\text{A}$ | Terminal | | | 1.55 | V |
| | | | Chip | | | 1.46 | |
| | $V_{(T0)}^{*1}$ | $T_j = 125^\circ\text{C}$ | | | | 0.75 | V |
| | r_t^{*1} | $T_j = 125^\circ\text{C}$ | | | | 0.51 | m Ω |
| トリガゲート電流 Gate Current to Trigger | I_{GT} | $V_D = 6\text{V}$, $I_T = 1\text{A}$ | $T_j = -40^\circ\text{C}$ | | | 300 | mA |
| | | | $T_j = 25^\circ\text{C}$ | | | 150 | mA |
| | | | $T_j = 125^\circ\text{C}$ | | | 80 | mA |
| トリガゲート電圧 Gate Voltage to Trigger | V_{GT} | $V_D = 6\text{V}$, $I_T = 1\text{A}$ | $T_j = -40^\circ\text{C}$ | | | 5 | V |
| | | | $T_j = 25^\circ\text{C}$ | | | 3 | V |
| | | | $T_j = 125^\circ\text{C}$ | | | 2 | V |
| 非トリガゲート電圧 Gate Non-Trigger Voltage | V_{GD} | $T_j = 125^\circ\text{C}$, $V_D = 2/3V_{DRM}$ | | 0.25 | | | V |
| 臨界オフ電圧上昇率 Critical Rate of Rise of Off-State Voltage | dv/dt | $T_j = 125^\circ\text{C}$, $V_D = 2/3V_{DRM}$, $R_{GK} = 33\Omega$ | | 500 | | | V/ μs |
| ターンオフ時間 Turn-Off Time | t_q | $T_j = 125^\circ\text{C}$, $I_{TM} = I_T$, $V_D = 2/3V_{DRM}$ dv/dt= 20V/ μs , $V_R = 100\text{V}$, -di/dt= 20A/ μs | | | 300 | | μs |
| ターンオン時間 Turn-On Time | t_{gt} | | | | 6 | | μs |
| 遅れ時間 Delay Time | t_d | $T_j = 25^\circ\text{C}$, $V_D = 2/3V_{DRM}$ $I_G = 300\text{mA}$, diG/dt= 0.2A/ μs | | | 2 | | μs |
| 立上がり時間 Rise Time | t_r | | | | 4 | | μs |
| ラッチング電流 Latching Current | I_L | $T_j = 25^\circ\text{C}$ | | | 150 | | mA |
| 保持電流 Holding Current | I_H | $T_j = 25^\circ\text{C}$ | | | 60 | | mA |
| 熱抵抗 Thermal Resistance | $R_{th(j-c)}$ | 接合部-ケース間(Tc 測定点: チップ直下) Junction to Case | | | | 0.07 | $^\circ\text{C}/\text{W}$ |
| 接触熱抵抗 Thermal Resistance | $R_{th(c-f)}$ | ケース-フィン間, サーマルコンパウンド塗布 Case to Fin, Greased | | | | 0.05 | $^\circ\text{C}/\text{W}$ |

質量 --- 約 450g Approximate Weight

1 アーム当りの値 Value Per 1 Arm.

*1 : $V_T \doteq V_{(T0)} + I_T \times r_t$ For power-loss calculation only

オン電圧特性
ON-STATE CURRENT VS. VOLTAGE

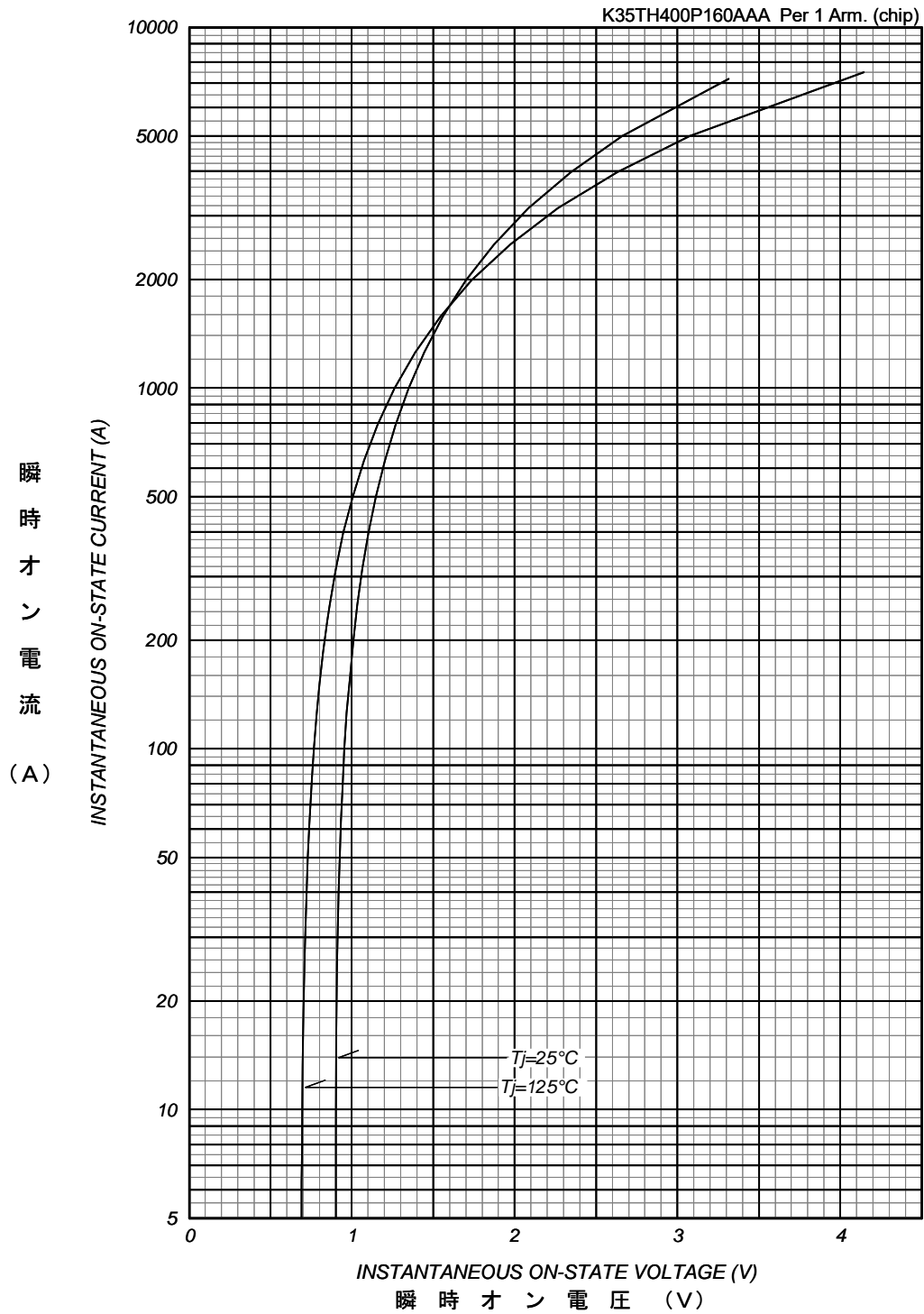

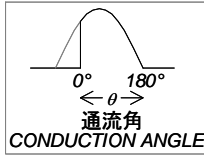

平均オン電力損失特性
 AVERAGE ON-STATE POWER DISSIPATION

for SINUSOIDAL CURRENT WAVEFORM

K35TH400P160AAA Per 1 Arm. (chip)

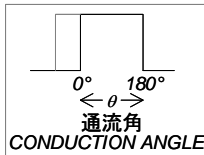
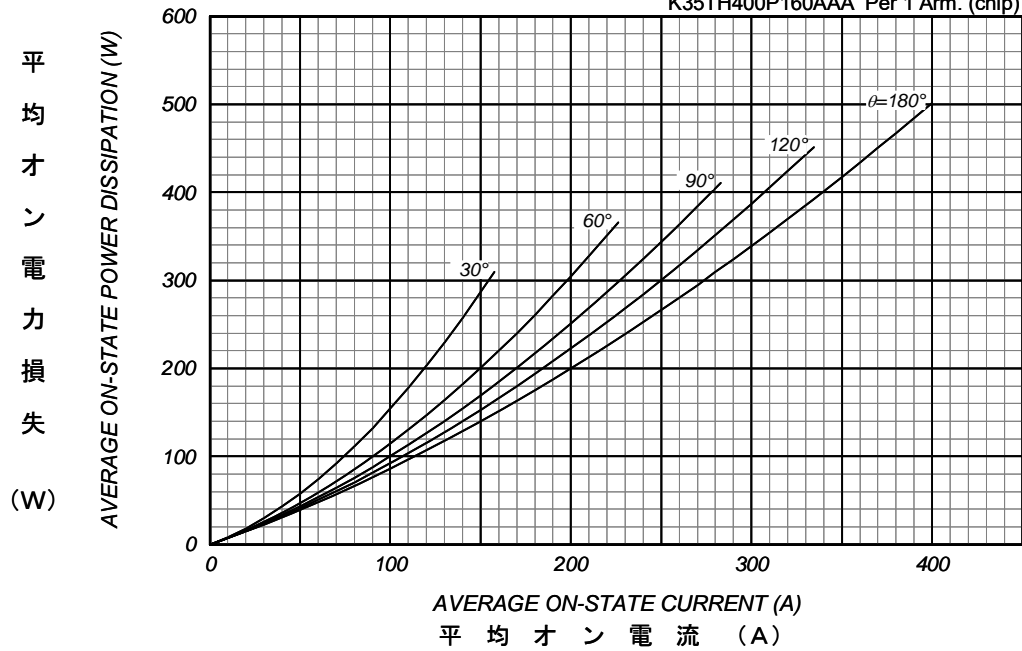

平均オン電力損失特性
 AVERAGE ON-STATE POWER DISSIPATION

for RECTANGULAR CURRENT WAVEFORM

K35TH400P160AAA Per 1 Arm. (chip)

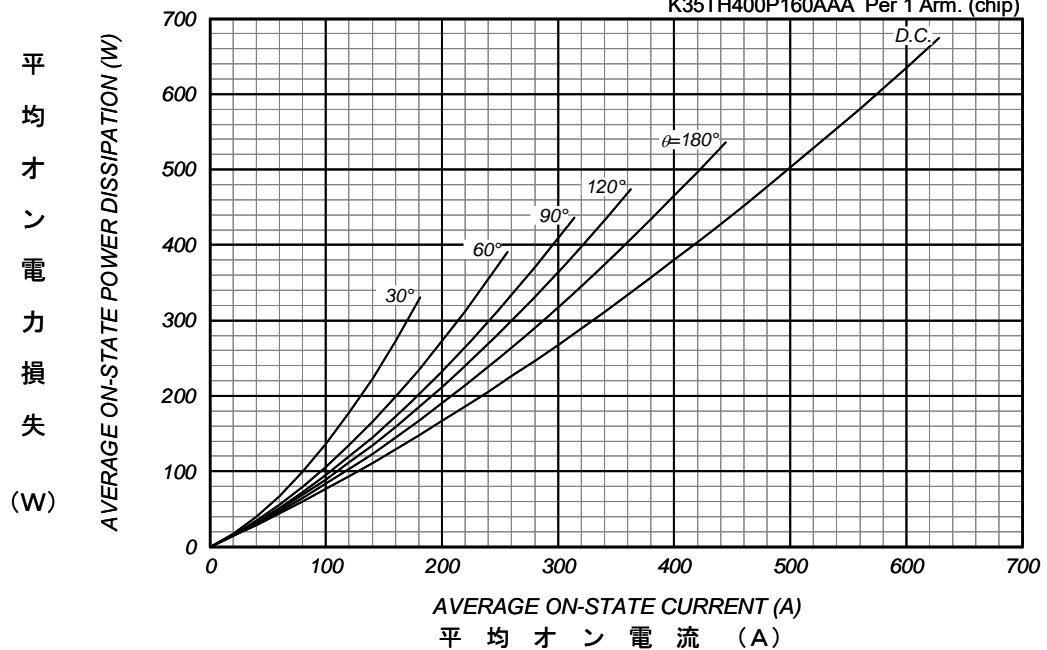

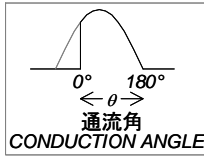

平均オン電流 - ケース温度定格
AVERAGE ON-STATE CURRENT VS. CASE TEMPERATURE

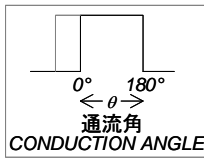
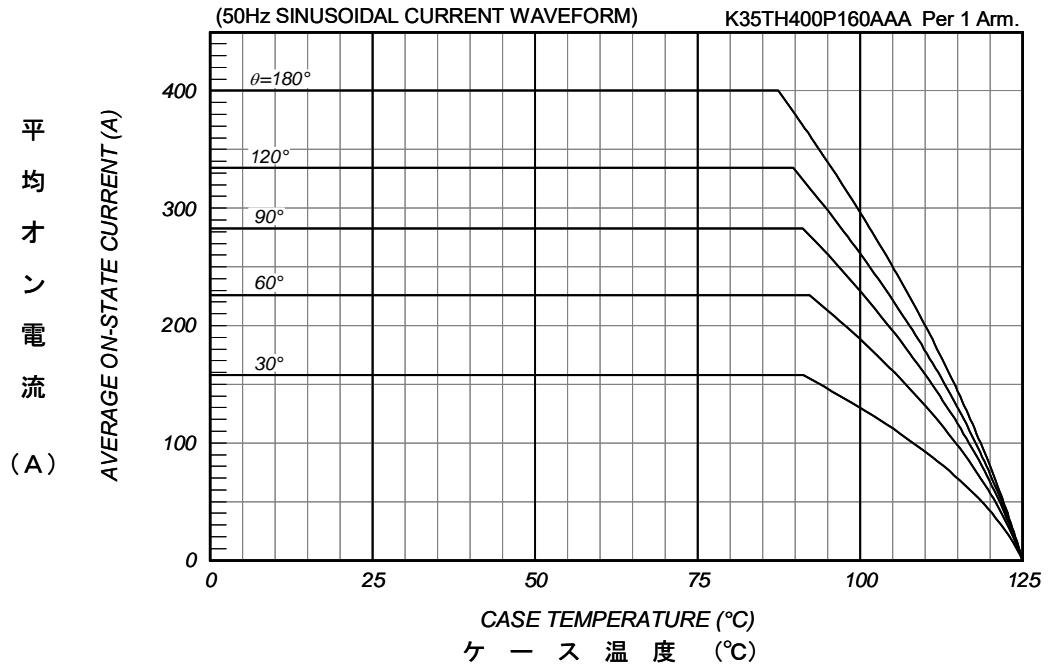

平均オン電流 - ケース温度定格
AVERAGE ON-STATE CURRENT VS. CASE TEMPERATURE

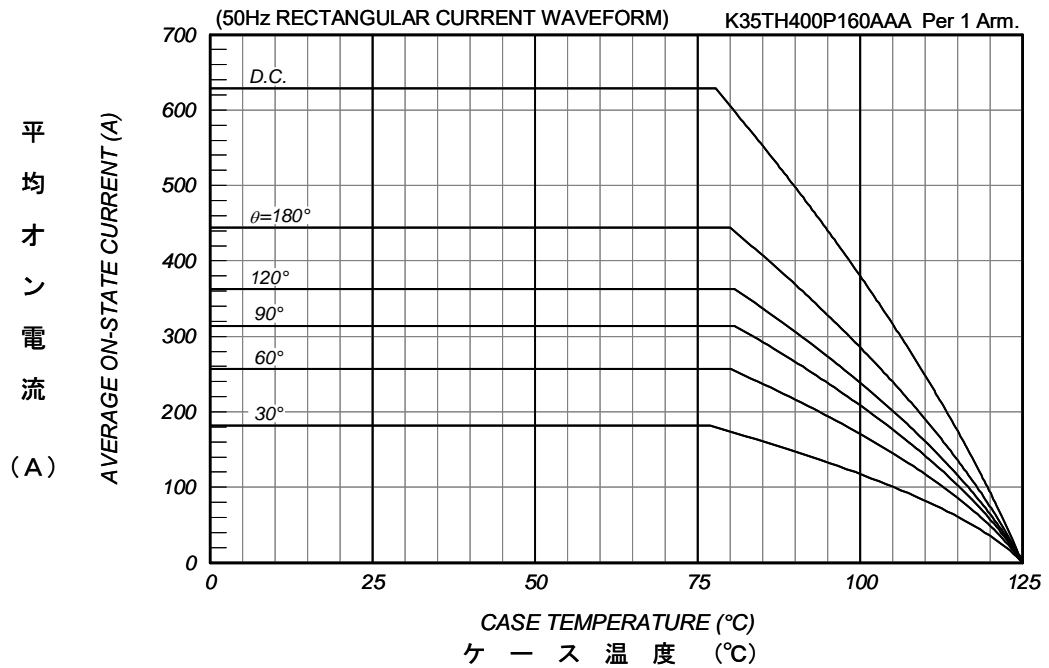

ゲート特性
GATE CHARACTERISTICS

K35TH400P160AAA

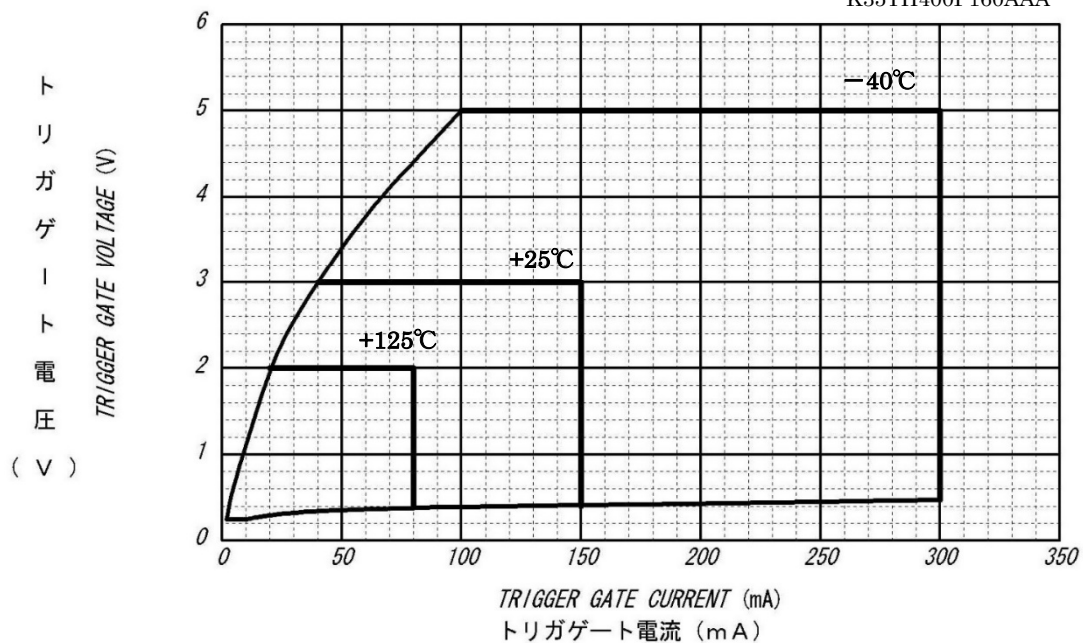

ゲート定格
GATE RATINGS

K35TH400P160AAA

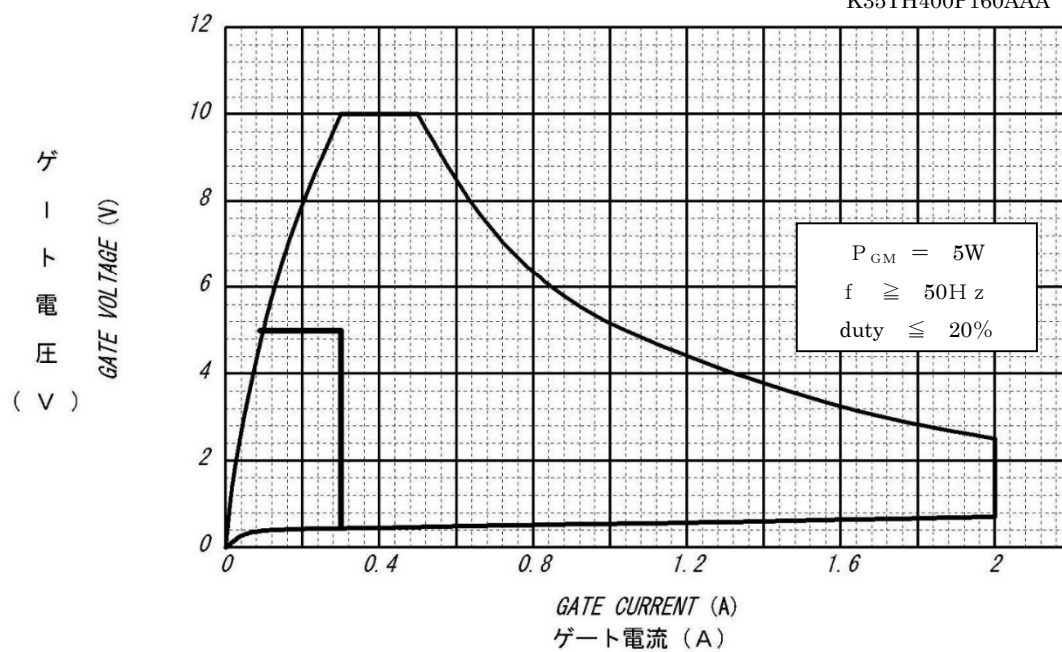

サージオン電流定格
SURGE CURRENT RATINGS

f=50Hz, Half Sine Wave, Non-Repetitive, On Load

K35TH400P160AAA Per 1 Arm.

サ
ー
ジ
オ
ン
電
流

(A)

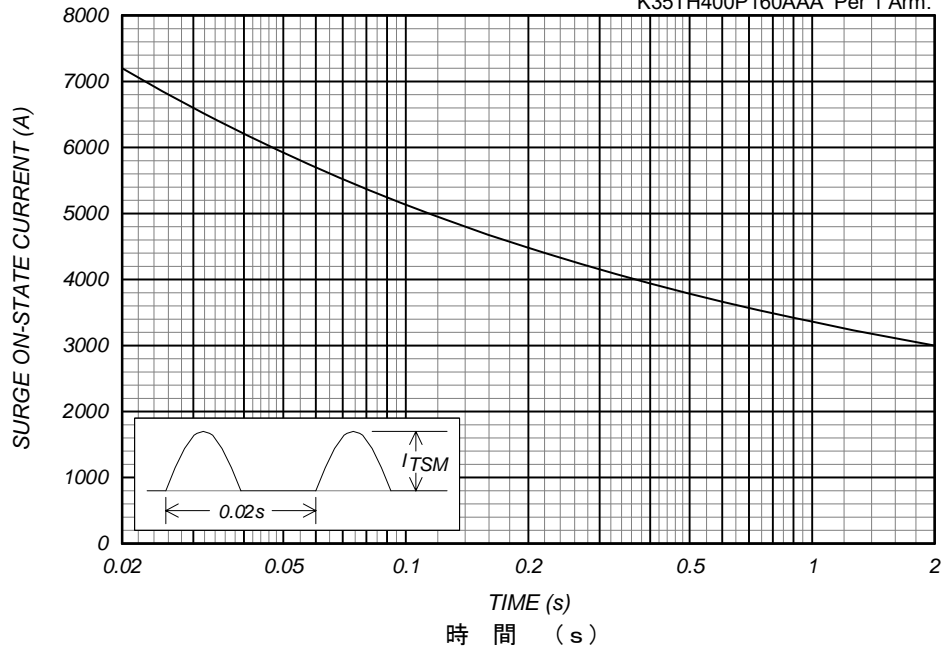

過渡熱抵抗特性
Transient Thermal Impedance

K35TH400P160AAA Per 1 Arm.

過
渡
熱
抵
抗

(°C/W)

